

# PRODUCT CATALOG

## AIR-TO-AIR HEAT EXCHANGERS

**HEATEX**

THE AIR-TO-AIR HEAT TRANSFER SPECIALIST

# OUR MISSION

*"Heatex's mission is to make the world safer, healthier, and more productive through the development and supply of energy-saving products and solutions.*

- *We make good indoor air quality a net saving rather than a cost*
- *We protect sensitive equipment critical in modern society*
- *We help reduce overall energy consumption, including fossil fuels and protect our environment for future generations."*

*/Frank Schmidt CEO*

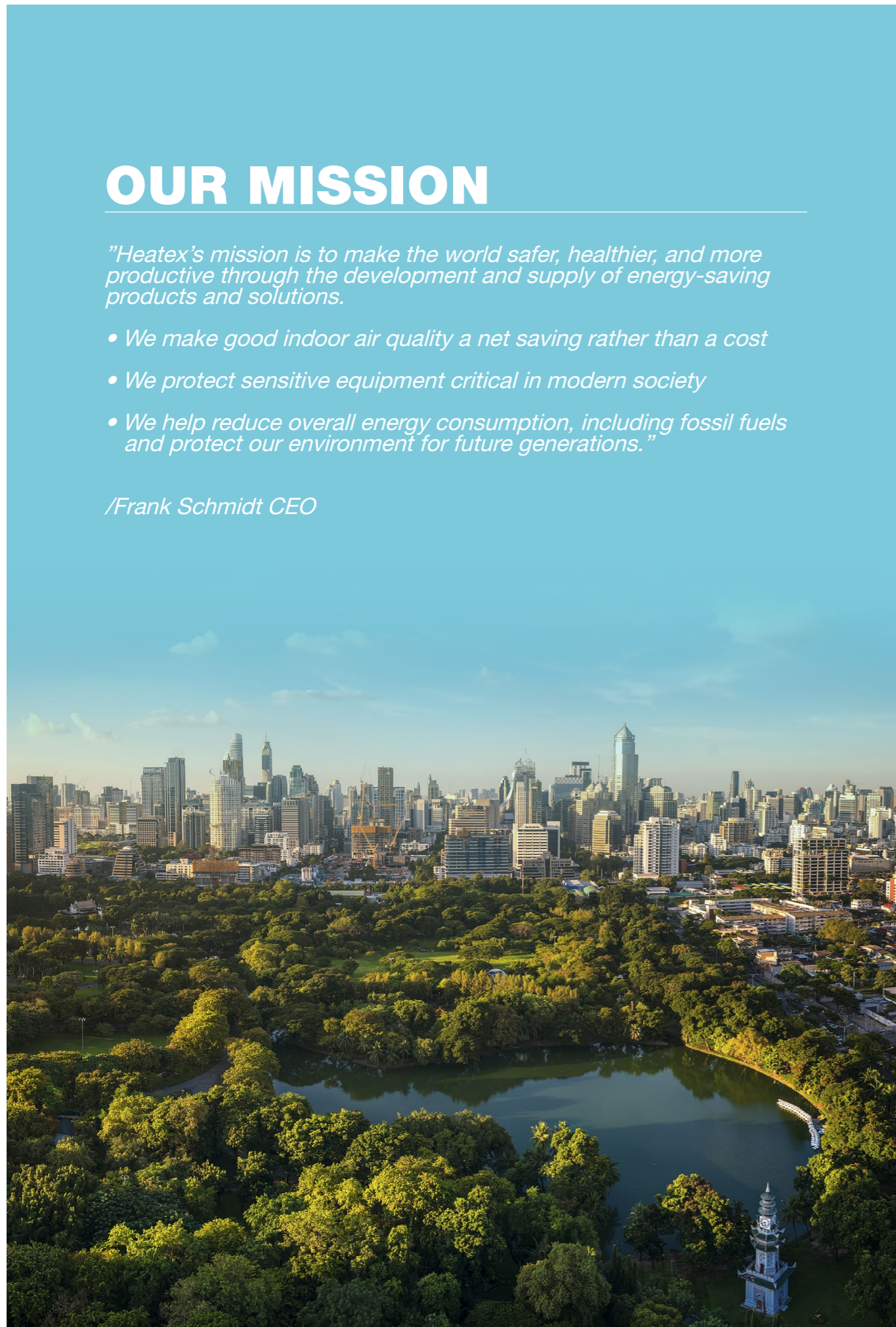

## HEATEX

Heatex is a leading cleantech company that optimizes and develops energy-saving thermodynamic products and solutions that save cost and contribute to a sustainable future.

Established in 1987, guided by our core values Excellence, Honesty, and Simplicity, Heatex has today become one of the top manufacturers of air-to-air heat exchangers in the world and a trusted partner to both global corporates and local champions.

Heatex is part of Madison Industries, one of the world's largest and most successful privately held companies. Madison builds entrepreneurially driven, branded market leaders committed to making the world safer, healthier, and more productive by creating innovative solutions that deliver outstanding customer value.

## PRODUCTS & SOLUTIONS

Heatex specializes in air-to-air heat exchangers whose purpose is to: (a) make good indoor air quality a net saving rather than a cost; and (b) protect sensitive equipment from excessive temperatures by maximizing the heat transfer between air flows.

By maximizing the heat transfer between air flows, we recover otherwise wasted heat (energy), thereby financially reducing costs and environmentally cutting carbon emissions. We specialize in custom solutions that provide optimal energy recovery and fast return on investment no matter the application.

## APPLICATIONS

Heatex heat exchangers are used in a variety of buildings, industries, and applications. The application determines which heat exchangers and/or systems provide the best solution.

AHU manufacturers use Heatex heat exchangers as key components in HVAC systems to transfer heat or control humidity between supply and exhaust airstreams (see Indoor Air Quality).

Air-to-air heat exchangers also enable reliable and energy-efficient cooling of heat-emitting processes such as sensitive electronics and generators (see Thermal Management).

# INDOOR AIR QUALITY

## COMMERCIAL & RESIDENTIAL VENTILATION

HVAC systems play a crucial role to maintain healthy and comfortable indoor air quality (IAQ) in almost all buildings.

Research shows good IAQ substantially helps improve productivity in business, raise grades in schools, and minimize hazardous pathogens in the air. Most often, good IAQ is best realized through fresh air exchange as opposed to recirculation.

The challenge for real estate owners and landlords is providing a healthy and comfortable IAQ with as little energy input (=cost) as possible.

With Heatex air-to-air heat exchangers, as much as 90% of the energy cost for tempering supply air can be saved and the return on investment is in many cases less than 12 months.



## INDUSTRIAL VENTILATION

Many industrial processes generate large amounts of hot and humid air.

These processes have a great potential for energy/heat recovery and air pollution control, which can significantly reduce energy consumption (= cost) and environmental impact.

When large amounts of waste heat are generated, air-to-air heat exchangers are employed to recover the otherwise wasted heat and preheat the incoming process air—resulting in significantly reduced operating costs.

Heatex air-to-air heat exchangers are ideal for numerous industrial applications, including dehumidification and water removal, process heat or refrigeration recovery, and humidity transfer.

# THERMAL MANAGEMENT

## DATA CENTER COOLING

Thermal Management is a key factor in the cost and operation of data centers.

Heatex heat exchangers, especially when coupled with evaporative cooling technology, provide an efficient, low cost and environmentally friendly alternative to remove excess heat from data center air.



## WIND TURBINE COOLING

To ensure the life expectancy of the components inside the nacelle the heat generated by the process of energy conversion and solar radiation needs to dissipate.

Heatex develops complete and customized air-to-air cooling systems for generator, nacelle and converter/ transformer cooling. All systems are suitable for both onshore and offshore applications due to their corrosion resistant closed loop design.

## ELECTRONIC COOLING

Electronic equipment constantly gets more sophisticated and sensitive. To function reliably, it needs to be protected from water, dust, and excess heat.

Heatex develops complete closed-loop cooling systems based on air-to-air heat exchangers for a variety of enclosures and cabinets used in telecom, digital media, and solar applications. All systems are highly flexibel and customizable.



## INDOOR AGRICULTURE

Greenhouse cultivation is an energy-intensive sector, energy consumption for indoor grow operations are many times higher than of typical office buildings.

Almost 50% of the energy use stems from ventilation, cooling, and dehumidification.

Air handling units equipped with an Heatex air-to-air heat exchanger can save 60% -70% of the energy required to control climate typical greenhouse grow facilities.



## PLATE HEAT EXCHANGERS

Heatex offers a broad range of plate heat exchangers. All units are produced according to our standardized processes with our proprietary production equipment at our global facilities, ensuring uniform product quality and favorable lead times worldwide.

### ADVANTAGES

- **HIGH EFFICIENCY**  
With Heatex heat exchangers, up to 90% of the heat in the exhaust air is transferred to the supply air.
- **LONGEVITY**  
No moving parts and strong aluminium plates in high standard alloy give the products a long lifetime and minimal need of service.
- **EASY MAINTENANCE**  
The design allows for rapid and thorough cleaning and servicing.
- **FULLY CUSTOMISED**  
All of our products are carefully designed to meet the demands for each specific application application and minimize the investment relative to the energy recovery need.
- **WIDE RANGE OF OPTIONS**  
We offer an extensive range of design options regarding materials, sizes and components to suit various application and performance requirements.
- **CLOSED LOOP AIR STREAMS**  
Depending on the application requirements, Heatex plates enable closed-loop airstreams to protect both people and equipment.

## CROSS FLOW HEAT EXCHANGERS

# COMPARE MODELS



Every model has a clear advantage depending on the application. To determine which model suits your application, please use our comparison table below.

MODEL	H2	H	P	Z
<b>Description</b>	Oustanding efficiency for commercial ventilation and high performance cooling.	Particular low pressure drop for basic ventilation and cooling applications.	Extra differential pressure resilience for industrial ventilation applications.	Exceptional durability and corrosion resistance for very tough applications.
<b>Efficiency</b>	Superior	High	High	High
<b>Airflow capacity</b>	Standard	High	High	Standard
<b>Plate material</b>	Aluminum/ epoxy	Aluminum/ epoxy	Aluminum/ epoxy	Stainless steel
<b>Combined modules size</b>	500 - 3000 mm	200 - 3000 mm	600 - 3000 mm	600, 1200, 1800 & 2400 mm
<b>Max. differential pressure*</b>	3000 Pa	1800 Pa	3800 Pa	4000 Pa

\* Depends on size and plate distance

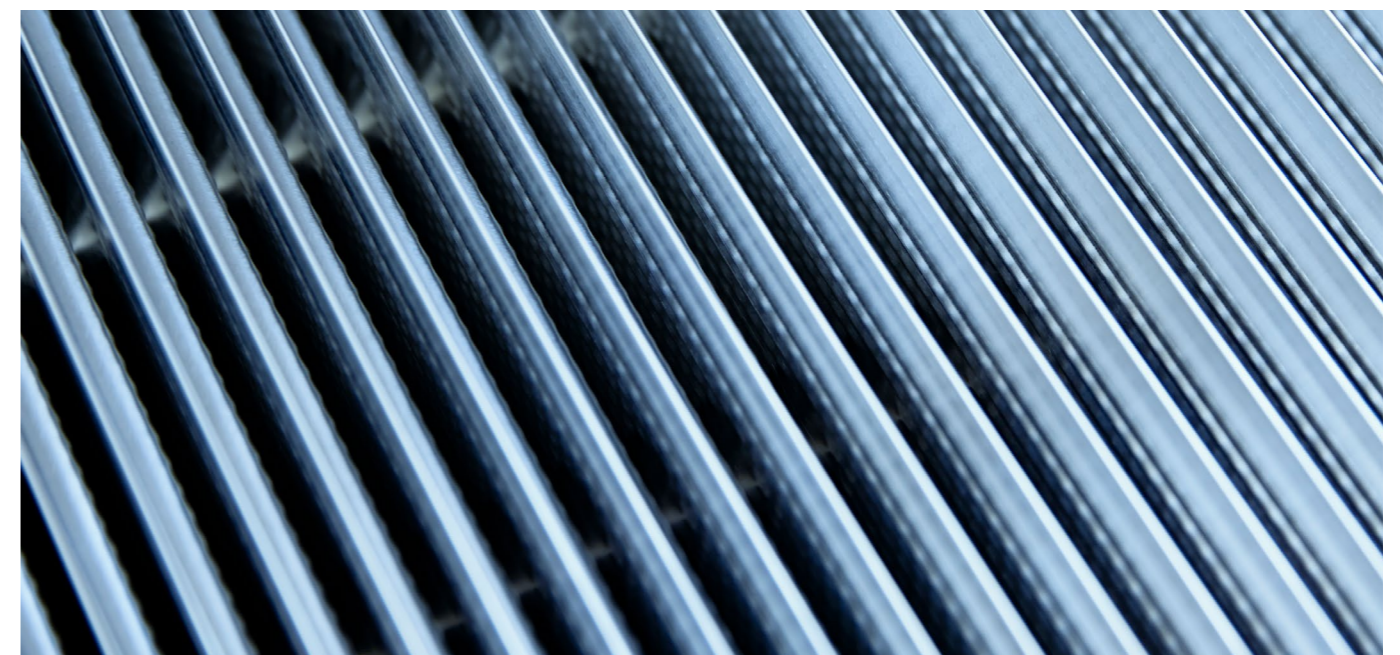

CROSS FLOW HEAT EXCHANGER

# MODEL H2

## Outstanding Efficiency

Model H2 is our most efficient cross flow plate heat exchanger. It combines low-weight with high differential pressure resistance and is able to reach typical dry temperature efficiencies above 80% and for two-step configurations over 90%. The efficiency is improved by its slim profiles and our superior efficiency plate design, creating high turbulence even at lower velocities while keeping pressure drop low.

Model H2's performance is certified according to Eurovent, AHRI and TüvSüd. It can be configured to comply with Ecodesign 1253/2014 requirements.

Heatex cross flow plate heat exchangers meet several hygiene requirements.

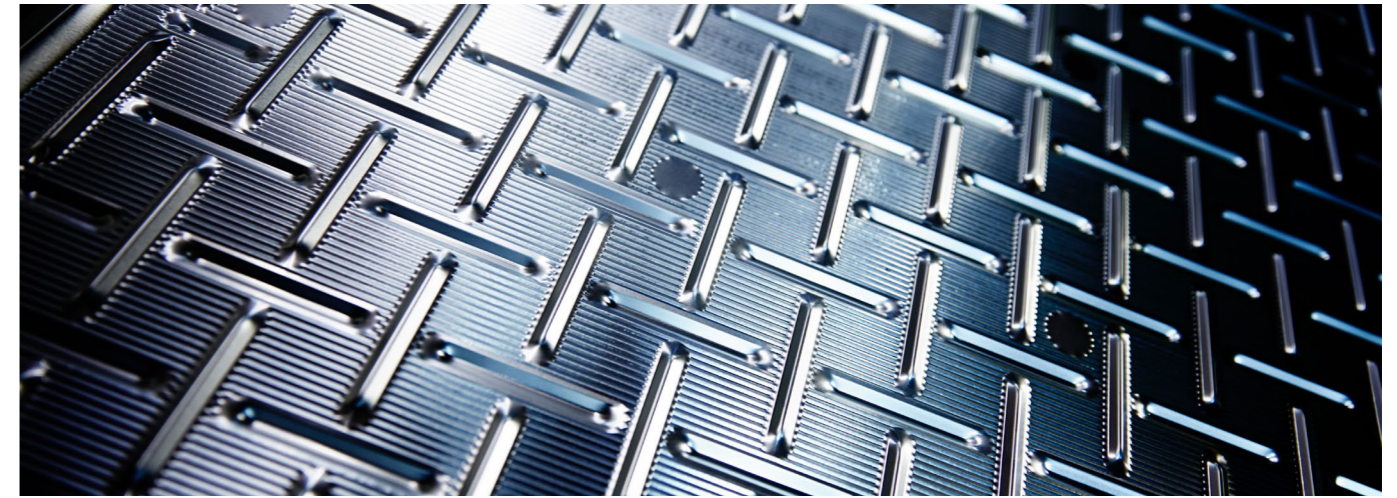

## MODEL H2 DIMENSIONS (MM)

**COMBINED MODULES SIZE:**

- 500 - 3000

**PLATE SIZE:**

- 500
- 600
- 700
- 750
- 850
- 1000
- 1200

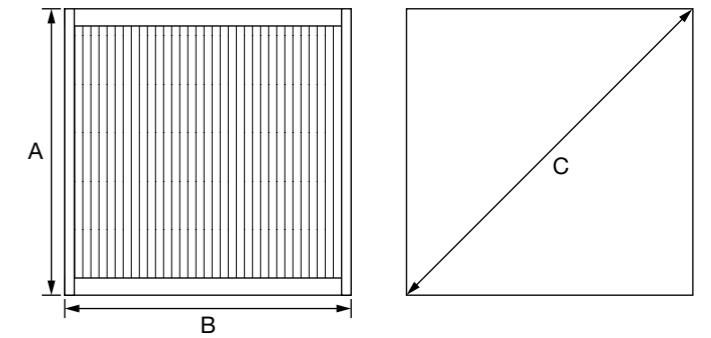

**NOTE:** Customized A-dimensions can to some extent be created with special corner profile designs.

## TECHNICAL SPECIFICATIONS & OPTIONS

**PLATE MATERIAL:**

- Aluminum
- Epoxy coated aluminium

**CORNER PROFILE:**

- 90° Aluminium profile
- 45° Aluminium profile

**END PLATE:**

- Aluzinc
- Aluminum

**SEALING:**

- Silicone free (max. 90°C)
- Silicone (max. 200°C)
- High temperature silicone (max. 240°C)

**MIN. ALLOWED TEMPERATURE:**

- -40°C

**MAX. LEAKAGE (IN %):**

- 0.1% of nominal airflow with non-silicone at 400 Pa
- 1% of nominal airflow for all models with silicone sealant

**ADDITIONAL OPTIONS:**

- Aquaseal tightness (max. 150°C)
- Laquered plate edges (max. 90°C)
- Corrosion protected framework (max. 90°C)
- Individual air tightness test + report
- Individual water tightness test + report
- ATEX testing (only available with aluminium plates)
- Heatex damper

**MAX. ALLOWED DIFFERENTIAL PRESSURE:**

- 1800 - 3000 Pa, depending on plate spacing
- > 3000 Pa for plate spacing above 4 mm

For H2 1200/2400:

- 1500 - 1700 Pa for plate spacing 2.0 mm - 3.0 mm
- > 3000 Pa for plate spacing above 4 mm

MODEL	A	B*	C45**	C90***	PLATE DISTANCE
500	500	250 - 1000	688	707	1.9 / 2.0 / 2.5 / 3.0 / 4.0 / 5.0 / 6.0
600	600	250-1200	829	849	1.9 / 2.0 / 2.2 / 2.5 / 3.0 / 4.0 / 5.0 / 6.0
700	700	300-1200	970	990	2.0 / 2.5 / 3.0 / 4.0 / 5.0 / 6.0
750	750	300-1200	1041	1061	2.0 / 2.1 / 2.5 / 3.0 / 4.0 / 5.0 / 6.0
850	850	300-1200	1182	1202	2.0 / 2.1 / 2.2 / 2.5 / 3.0 / 4.0 / 5.0 / 6.0
1000	1000	350-1200	1394	1414	2.0 / 2.5 / 2.7 / 3.0 / 4.0 / 5.0 / 6.0
1200	1200	350-1200	On request	1697	2.0 / 2.5 / 2.7 / 2.8 / 3.0 / 4.0 / 5.0 / 6.0 / 8.5 / 10.0
1400	1400	350-1200	1960	1980	2.0 / 2.5 / 3.0 / 4.0 / 5.0 / 6.0
1500	1500	350-1200	2102	2122	2.0 / 2.5 / 3.0 / 4.0 / 5.0 / 6.0
1700	1700	350-1200	2384	2404	2.0 / 2.5 / 3.0 / 4.0 / 5.0 / 6.0
2000	2000	350-1200	2808	2828	2.0 / 2.5 / 3.0 / 4.0 / 4.3 / 4.8 / 5.0 / 6.0
2250	2250	350-1200	3162	3182	2.0 / 2.5 / 3.0 / 4.0 / 5.0 / 5.5 / 6.0
2400	2400	350-1200	3374	3394	2.0 / 2.5 / 2.7 / 2.8 / 3.0 / 4.0 / 5.0 / 5.5 / 6.0 / 8.5 / 10.0
2550	2550	350-1200	3586	3606	2.0 / 2.5 / 3.0 / 4.0 / 5.0 / 6.0
3000	3000	350-1200	4223	4243	2.0 / 2.5 / 3.0 / 4.0 / 5.0 / 6.0

\* Maximum module width depends on plate orientation (vertical or horizontal), model and plate distance.

\*\* 45° corner profile.

\*\*\* 90° corner profile.

CROSS FLOW HEAT EXCHANGER

# MODEL H

Low Pressure Drop

Model H is Heatex' original cross flow plate heat exchanger with typical dry temperature efficiency up to 75% for a single pass and 85% for two-step arrangements.

Model H offers the widest set of options and configurations among our cross flow plate heat exchangers.

Model H's performance is certified according to Eurovent, AHRI, and TüvSüd. It can be configured to comply with Ecodesign 1253/2014 requirements.

Heatex cross flow plate heat exchangers meet several hygiene requirements.

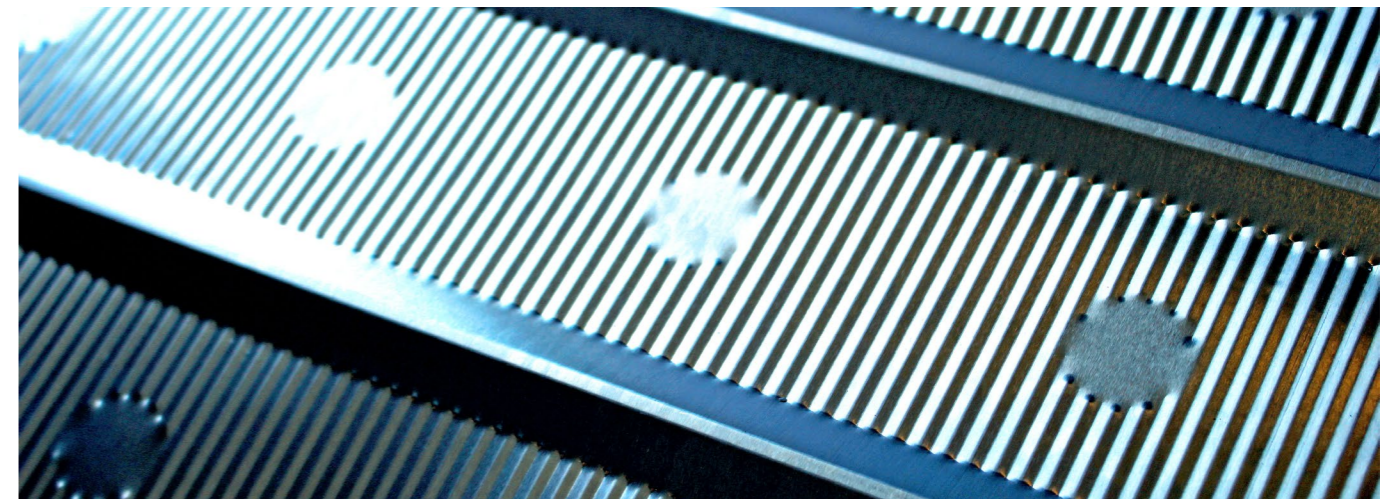

## TECHNICAL SPECIFICATIONS & OPTIONS

**PLATE MATERIAL:**

- Aluminium
- Epoxy coated aluminium

**CORNER PROFILE:**

- 90° Aluminium
- 45° Aluminium

**END PLATE:**

- Aluzinc (for plate size > 600 mm)
- Aluminium (for plate size < 300 mm)

**SEALING:**

- Silicone free (max. 90°C)
- Silicone (max. 200°C)
- High temperature silicone (max. 240°C)

**MIN. ALLOWED TEMPERATURE:**

- -40°C

**MAX. LEAKAGE:**

- 0.1% of nominal air flow for sizes > 425 mm at 400 Pa
- 1% of nominal airflow for sizes < 425 mm at 250 Pa
- 1% of nominal airflow for all models with silicone sealant

**ADDITIONAL OPTIONS:**

- Aquaseal tightness (max. 150°C)
- Laquered plate edges (max. 90°C)
- Corrosion protected framework (max. 90°C)
- Individual air tightness test + report
- Individual water tightness test + report
- ATEX testing (only available with aluminium plates)
- Heatex damper

**MAX. ALLOWED DIFFERENTIAL PRESSURE:**

- 1800 Pa for most sizes
- 700 Pa for size 200 mm and 300 mm

## MODEL H DIMENSIONS (MM)

**COMBINED MODULES SIZE:**

- 200 - 3000

**PLATE SIZE:**

- 200
- 300
- 415
- 425
- 600
- 750
- 800
- 850
- 1000

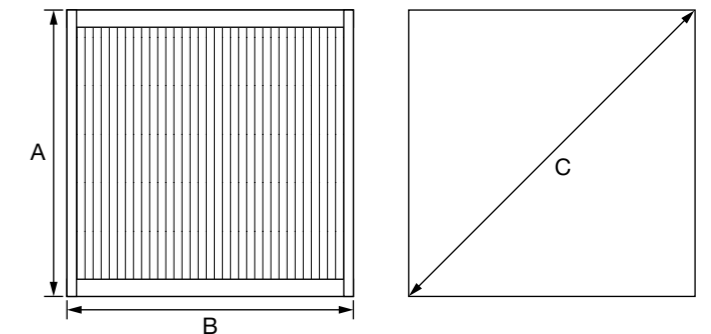

**NOTE:** Customized A-dimensions can to some extent be created with special corner profile designs.

MODEL	A	B	C45*	C90**	PLATE DISTANCE
200	200	100-600	265	283	1.6/2.1/2.4/2.7
300	300	100-600	406	424	1.8/2.2/3.0/4.0/5.0
415	415	200-700	548	587	3.3/4.2/5.0/6.5
425	425	200-1000	587	601	3.3/4.2/5.0/6.5
600	600	250-1200	829	849	2.7/3.0/4.5/6.0/7.5/9.0/10.5/12.0
750	750	300-1200	1041	1061	3.3/4.5/6.0/7.5/9.0/10.5/12.0
800	800	300-1200	-	1131	3.3/4.5/6.0/7.5/9.0/10.5/12.0
850	850	300-1200	1182	1202	3.0/3.5/4.0/5.0/6.5/8.0/9.5
1000	1000	350-1200	1394	1414	3.3/3.7/5.0/6.0/7.5/9.0/10.5/12.0
1200	1200	350-1200	1677	1697	2.7/3.0/4.5/6.0/7.5/9.0/10.5/12.0
1500	1500	350-1200	2102	2122	3.3/4.5/6.0/7.5/9.0/10.5/12.0
1700	1700	350-1200	2384	2404	3.0/4.0/4.5/5.0/6.5/8.5/10.5/12.0
2000	2000	350-1200	2808	2828	3.3/3.7/5.0/6.0/7.5/9.0/10.5/12.0
2250	2250	350-1200	3162	3182	3.3/4.5/6.0/7.5/9.0/10.5/12.0
2550	2550	350-1200	3586	3606	3.0/4.0/4.5/5.0/6.5/8.5/10.5/12.0
3000	3000	350-1200	4223	4243	5.0/6.0/7.5/9.0/10.5/12.0

\*45° corner profile.  
\*\*90° corner profile.

CROSS FLOW HEAT EXCHANGER

# MODEL P

Extra Resilience

Model P is a heavy duty, cross flow plate heat exchanger, specially designed for applications where high differential pressures occur. Efficiencies up to 75% for single units and up to 85% for two-step arrangements are typical.

Based on the same well-proven plate design as Model H, Model P's efficiency is similar but offers a higher differential pressure resistance due to its extra-strong aluminum plates.

Model P is our most robust aluminum cross flow plate heat exchanger.

Model P's performance is certified according to Eurovent and TüvSüd. It can easily be configured to comply with Ecodesign 1253/2014 requirements.

All Heatex cross flow plate heat exchangers meet several hygiene requirements.

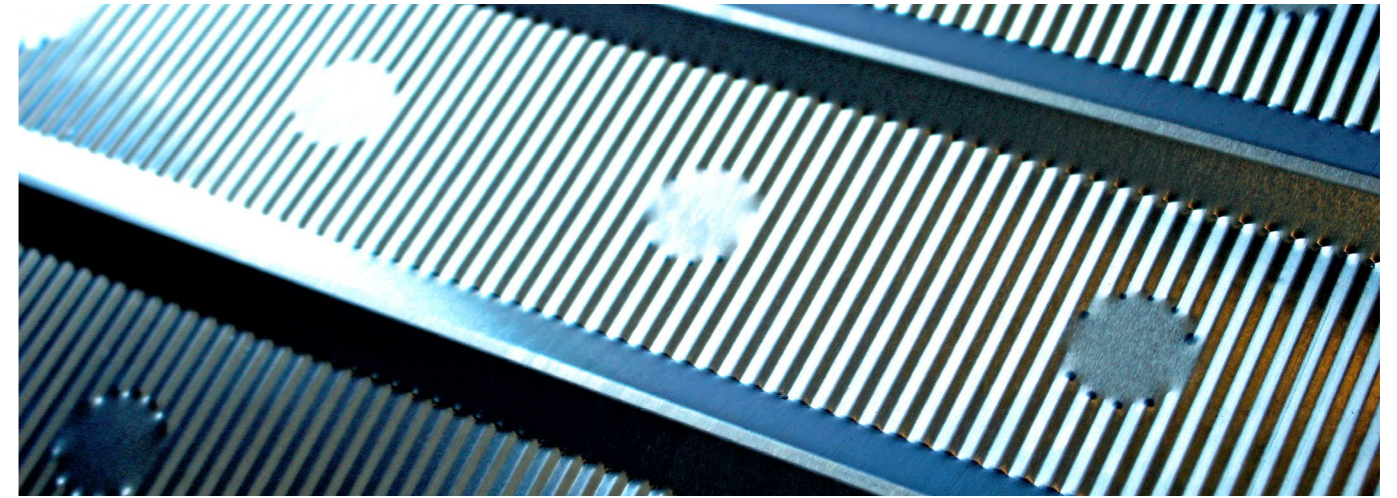

## MODEL P DIMENSIONS (MM)

**COMBINED MODULES SIZE:**

- 600 - 3000

**PLATE SIZE:**

- 600
- 750
- 850
- 1000

## TECHNICAL SPECIFICATIONS & OPTIONS

**PLATE MATERIAL:**

- Aluminium
- Epoxy coated aluminium

**CORNER PROFILE:**

- 90° Aluminium
- 45° Aluminium

**END PLATE:**

- Aluzinc (for plate size > 600 mm)

**MIN. ALLOWED TEMPERATURE:**

- -40°C

**MAX. LEAKAGE:**

- 0.1% of nominal air flow for sizes > 425 mm at 400 Pa
- 1% of nominal airflow for sizes < 425 mm at 250 Pa
- 1% of nominal airflow for all models with silicone sealant

**SEALING:**

- Silicone free (max. 90°C)
- Silicone (max. 200°C)
- High temperature silicone (max. 240°C)

**ADDITIONAL OPTIONS:**

- Aquaseal tightness (max. 150°C)
- Laquered plate edges (max. 90°C)
- Corrosion protected framework (max. 90°C)
- Individual air tightness test + report
- Individual water tightness test + report
- ATEX testing (only available with aluminium plates)
- Heatex damper

**MAX. ALLOWED DIFFERENTIAL PRESSURE:**

- < 3800 Pa

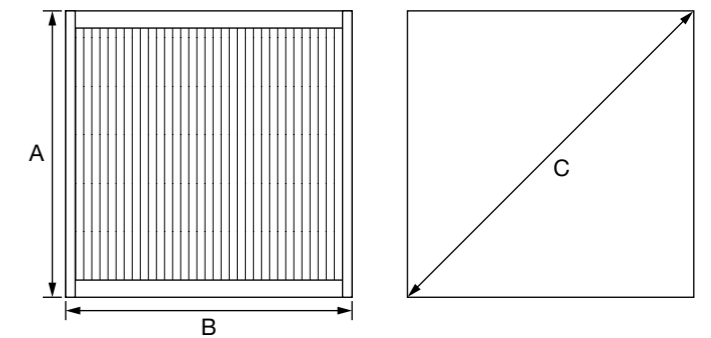

**NOTE:** Customized A-dimensions can to some extent be created with special corner profile designs.

MODEL	A	B	C45*	C90**	PLATE DISTANCE
600	600	250-1200	829	849	2.7/3.3/4.5/6.0/7.5/9.0/10.5/12.0
750	750	300-1200	1041	1061	3.3/4.5/6.0/7.5/9.0/10.5/12.0
850	850	300-1200	1183	1202	3.0/3.5/4.0/5.0/6.5/8.0/9.5
1000	1000	350-1200	1394	1414	3.3/3.7/5.0/6.0/7.5/9.0/10.5/12.0
1200	1200	350-1200	-	1697	2.7/3.0/4.5/6.0/7.5/9.0/10.5/12.0
1500	1500	350-1200	-	2122	3.3/4.5/6.0/7.5/9.0/10.5/12.0
1700	1700	350-1200	-	2404	3.0/3.5/4.0/5.0/6.5/8.5/10.5/12.0
2000	2000	350-1200	-	2828	5.0/6.0/7.5/9.0/10.5/12.0
2250	2250	350-1200	-	3182	3.3/4.5/6.0/7.5/9.0/10.5/12.0
2250	2250	350-1200	-	3606	3.0/3.5/4.0/5.0/6.5/8.5/10.5/12.0
3000	3000	350-1200	-	4243	5.0/6.0/7.5/9.0/10.5/12.0

\*45° corner profile.  
\*\*90° corner profile.

# MODEL Z

## Exceptional Durability

Model Z is designed to operate in corrosive environments and heavy duty applications. The entire unit is made of acid resistant stainless steel and a single pass exchanger can provide a sensible efficiency of 65 – 70%.

Based on the same well-proven plate design as Model H, Model Z's efficiency is similar to Model H but offers even higher differential pressure resistance due to its stainless steel plates. Model Z is our most durable cross-flow heat exchanger.

All Heatex cross flow plate heat exchangers meet several hygiene requirements.



## TECHNICAL SPECIFICATIONS & OPTIONS

### PLATE MATERIAL:

- Acid resistant stainless steel 1.4404 (ASTM 316)

### CORNER PROFILE:

- Acid resistant stainless steel 1.4404 (ASTM 316)

### ENDPLATE:

- Acid resistant stainless steel 1.4404 (ASTM 316)

### SEALING:

- Silicone free (max 90°C)
- Silicone (max 200°C)
- High temperature silicone (max 240°C)

### ADDITIONAL OPTIONS:

- Aquaseal tightness (max. 150°C)
- Laquered plate edges (max. 90°C)
- Individual air tightness test + report
- Individual water tightness test + report

### MAX. LEAKAGE (IN %):

Tested at 400 Pa (1.6" WC) differential pressure.

- 0.1% of nominal airflow with non-silicone sealant (with AquaSeal) and 0.5% (without AquaSeal)
- 5% of nominal airflow with silicone sealant (without AquaSeal)

### MAX. ALLOWED DIFFERENTIAL PRESSURE:

- < 4000 Pa

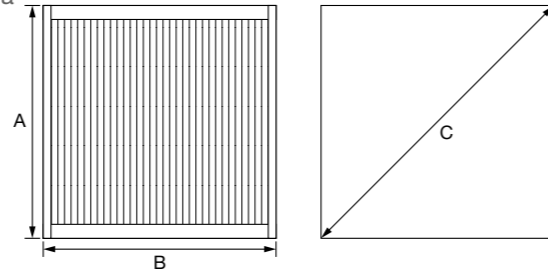

## DIMENSIONS (MM)

### COMBINED MODULES SIZE:

- 600, 1200, 1800 & 2400

### PLATE SIZES:

- 600

MODEL	A	B	C90*	PLATE DISTANCE
600	600	250-1200	849	6.0 / 7.5 / 9.0
1200	1200	350-1200	1697	6.0 / 7.5 / 9.0
1800	1800	350-1200	2546	6.0 / 7.5 / 9.0
2400	2400	350-1200	3394	6.0 / 7.5 / 9.0

\*90° corner profile.





# END PLATES & CORNER PROFILES

## END PLATES

An end plate is a part of the casing on a cross flow heat exchanger. There is one end plate on each side of the plate package. We call them A, C and E. "A" is a flat metal sheet, "C" is single folded (L-shaped) and type "E" has a double folded edge (U-shaped).

## CORNER PROFILE

The profile is the corner piece, placed on the same sides as the inlets- and outlets- of the cross flow heat exchanger. Together with the end plates, the profile creates the frame around the heat transfer plates.

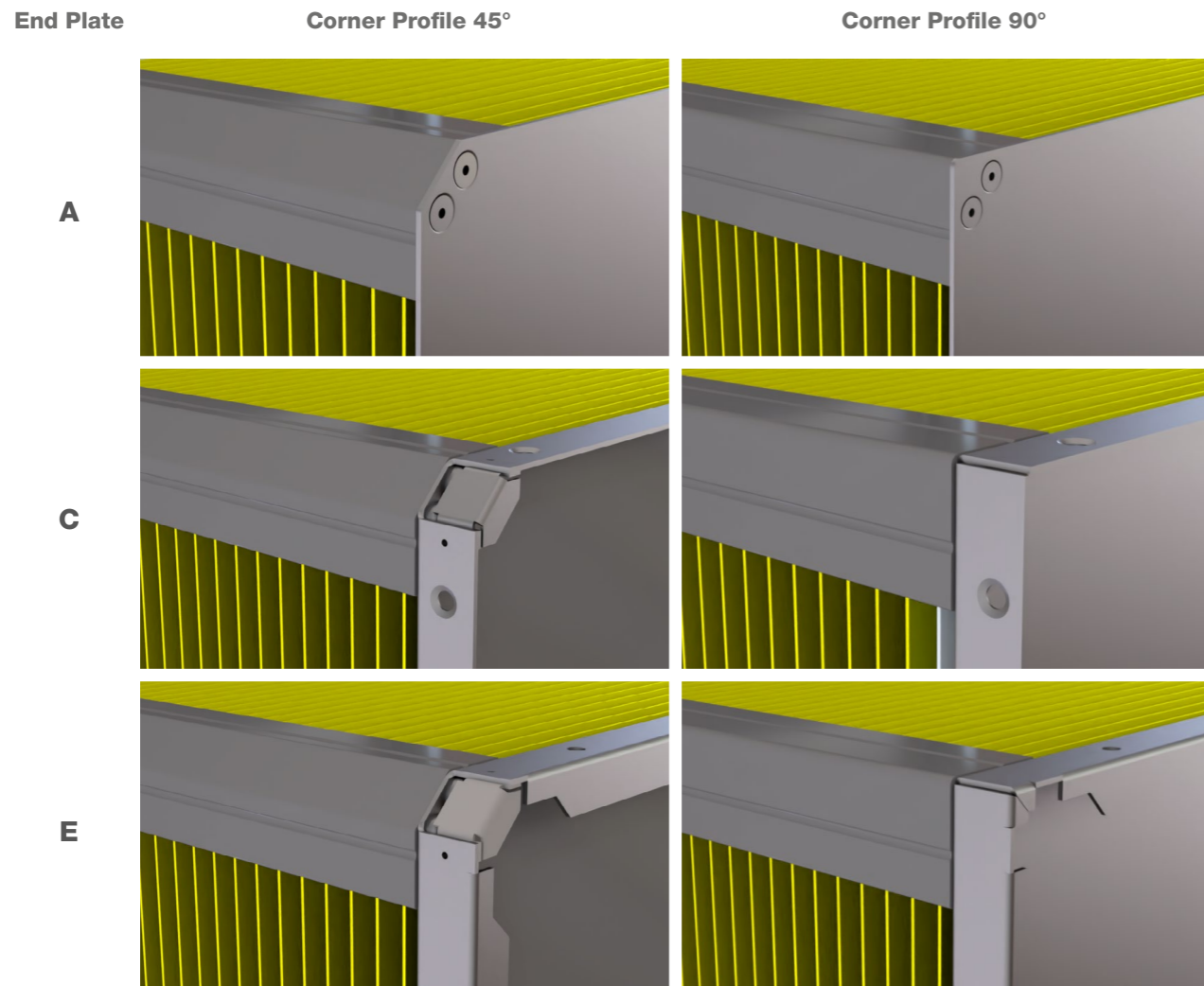

## MORE CORNER PROFILE DESIGNS

Special applications might demand different profile designs, please contact us for technical support.

# ADDITIONAL OPTIONS

## AQUASEAL

AquaSeal is a process used to fill all plate crevices with a special polymer. This will result in a highly tight heat exchanger, suitable for applications with high humidity or direct water exposure. As standard, for every heat exchanger applied with AquaSeal, a water tightness test is performed. AquaSeal only applies to exchangers with plate spacing > 4mm (0.16").

## LAQUERED PLATE EDGES

Since cutting the epoxy plates removes the epoxy coating along the edges, a lacquer is applied to protect the edges from corrosion. This option can also be used to tighten the heat exchanger further.

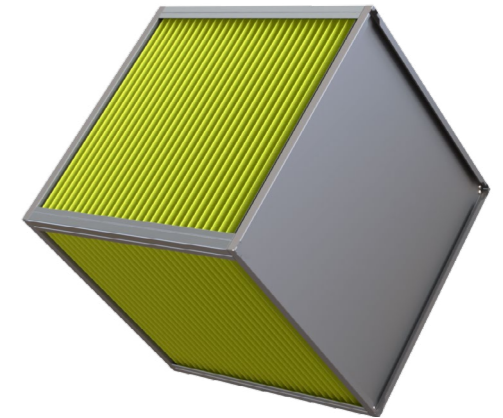

## CORROSION PROTECTED FRAMEWORK

Crossflow models are available with a metallic coating consisting of Zn, Al and Mg on a steel substrate. It has self-healing abilities which ensures edge protection. This coating fulfills corrosion protection class C5.

## DAMPERS

Suitable for close/open bypass exchanger section in connection with a cross-flow plate heat exchanger. Tightness classification 2.

### FRAME HEIGHT:

- 115 mm

### BLADE WIDTH/ DIVISION:

- 100 mm

### SQUARE SHAFT:

- 12 x 12 mm
- 50 - 200 mm in length

### ROUND SHAFT:

- 12 mm
- 120 mm in length

### MAXIMUM DAMPER WIDTH:

- 2500 mm (incl. bypass)

### MAXIMUM DAMPER-UNIT AREA:

- 4 m<sup>2</sup> (incl. bypass)

### MAXIMUM BLADE LENGTH:

- 1300 mm

### MATERIAL:

- Profiles and damper blades in aluminium
- Driving wheels in PP plastic with fiberglass (suitable for temperatures between -15°C to 80°C)

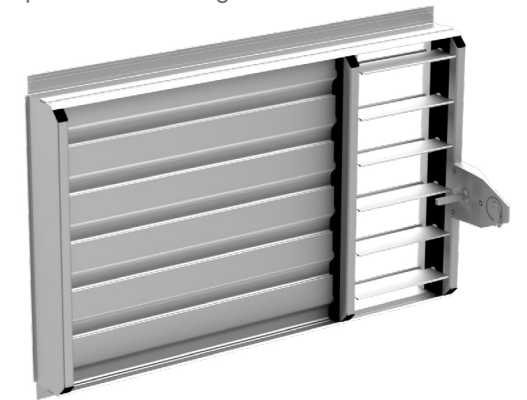

Required Torque Nm/m<sup>2</sup> at pressure difference 1500 Pa

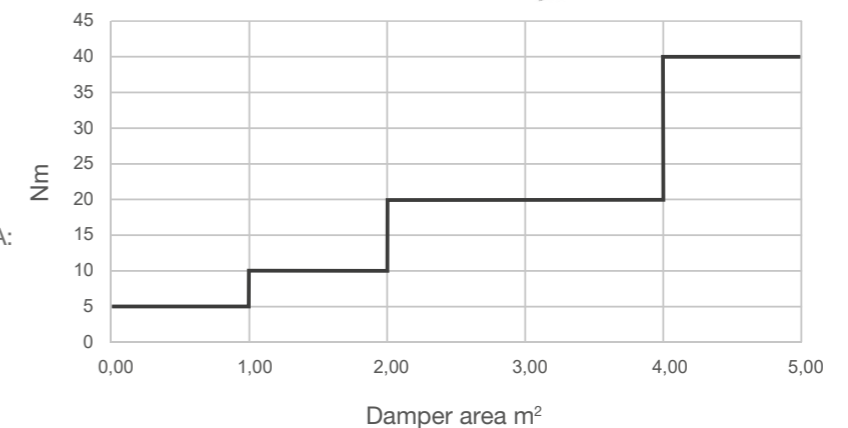

Values for 1 section + bypass-section. For each additional section add 3 Nm/m<sup>2</sup>.

COUNTER FLOW HEAT EXCHANGER

# MODEL M

**Slim & Flexible**

Model M is a slim, high-efficiency counterflow plate heat exchanger, specially designed for the demanding requirements of the telecommunications and solar industry. Even in a dry situation, it can come close to 90% (sensible) efficiency.

Especially for Model M, Heatex offers custom integration solutions for easy installation and faster end product delivery. Model M is built according to customers' request with either double L-flow, double U-flow or L+U-flow configuration.

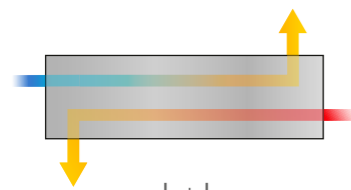
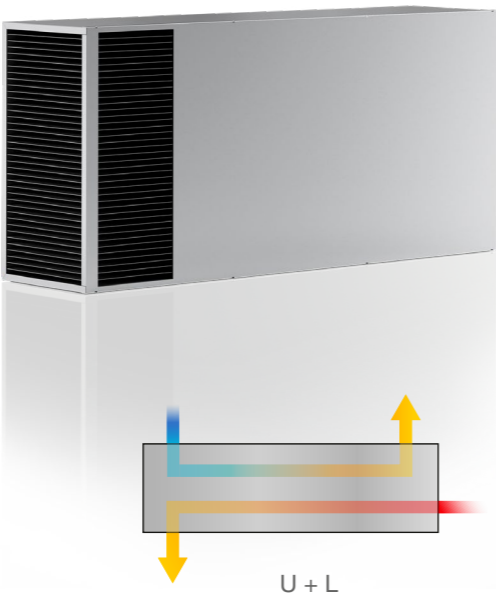

Most effective/recommended.

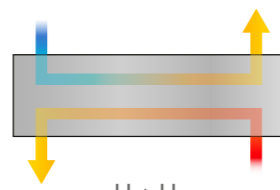

Alternative for special flow path requirements.

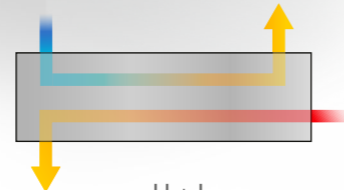

## TECHNICAL SPECIFICATIONS & OPTIONS

**PLATE MATERIAL:**

- Aluminium
- Epoxy coated aluminium

**CASING MATERIAL:**

- Aluzinc

**MAX. ALLOWED TEMPERATURE AND SEALING:**

- Silicone free (max 90°C)

**MAX. LEAKAGE:**

- 0.1% of nominal air flow at 400 Pa

**MAX. ALLOWED DIFFERENTIAL PRESSURE:**

- 700 Pa

## DIMENSIONS (MM)

**WIDTH/ LENGHT:**

- 100 - 600

**PLATE SIZE:**

- 95                      • 190
- 140                     • 235

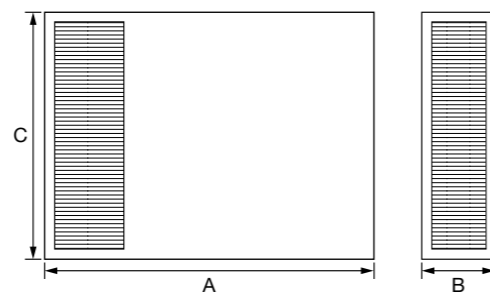

MODEL	A*	B	C	PLATE DISTANCE
200 - 500 x 95	200 - 500	95	100 - 600	3.0 / 4.5 / 6.0
300 - 600 x 140	300 - 600	140	100 - 600	3.0 / 4.5 / 6.0
400 - 1000 x 190	400 - 1000	190	100 - 600	3.0 / 4.5 / 6.0 / 7.5
500 - 1000 x 235	500 - 1000	235	100 - 700	3.0 / 4.5 / 6.0 / 7.5

\*Available in 100 mm increments. For further options please contact us!



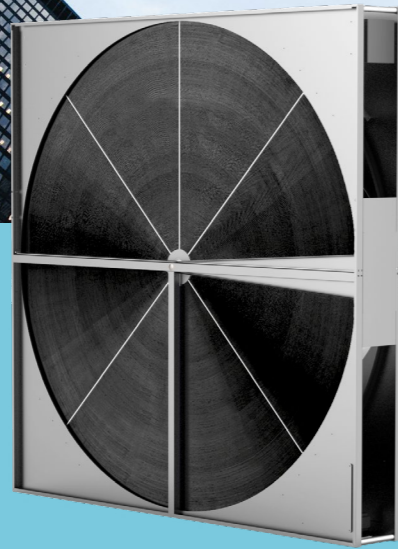

## ROTARY HEAT EXCHANGERS

All Heatex rotary heat exchangers share the same high-efficiency matrix and a wide variety of well-heights to suit various performance requirements. All units are produced at our global production facilities with our proprietary production equipment according to the same standardized processes, ensuring uniform product quality and favorable lead times worldwide.

### ADVANTAGES

- HIGH EFFICIENCY**  
 Heatex rotary exchangers provide high sensible and latent efficiencies.
- LOW FREEZING RISK**  
 Rotary heat exchangers offer a very low freezing risk as the wheels by definition defrost themselves.
- MINIMAL CROSS CONTAMINATION**  
 Models with casing are fitted with seals for excellent air tightness and can be equipped with purge sectors to minimize the cross-contamination of exhaust air into the supply air.
- HUMIDITY TRANSFER**  
 There are several possibilities to add various coatings to the wheel, to enable latent transfer or provide increased corrosion protection.
- WIDE RANGE OF OPTIONS**  
 We offer an extensive range of options regarding sizes, material, and drives to suit various application and performance requirements.
- FULLY CUSTOMISED**  
 All of our products are carefully designed to meet the demands for each specific application application and minimize the investment relative to the energy recovery need.

## ROTARY HEAT EXCHANGERS

# COMPARE MODELS

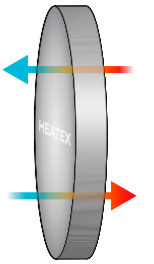

Every Model has a clear advantage depending on its application. All of our rotary heat exchangers share the same high-efficiency matrix. Model E offers one of the most compact casings on the market, whereas Model EQ features a segmented wheel for easy onsite installation or replacement in narrow spaces. Both wheels are also available without casing. Model EN is primarily designed for residential applications.

To determine which Model suits your application project, please use our comparison table below.

MODEL	E/O	EQ/EV	EN
<b>Airflow capacity</b>	200 - 90 000 Nm <sup>3</sup> /h	2000 - 190 000 Nm <sup>3</sup> /h	50 - 2000 Nm <sup>3</sup> /h
<b>Rotor design</b>	One piece	Segmented	One piece
<b>Configuration</b>	Model E: With casing  Model O: Without casing	Model EQ: With casing  Model EV: Without casing	Without casing
<b>Exchanger orientation</b>	Vertical or horizontal	Vertical only	Vertical or horizontal
<b>Rotor diameter</b>	500 - 2575 mm (Available in steps of 1 mm increments.)	1600 - 3800 mm (Available in steps of 1 mm increments.)	200 - 500 mm (Available in steps of 1 mm increments.)

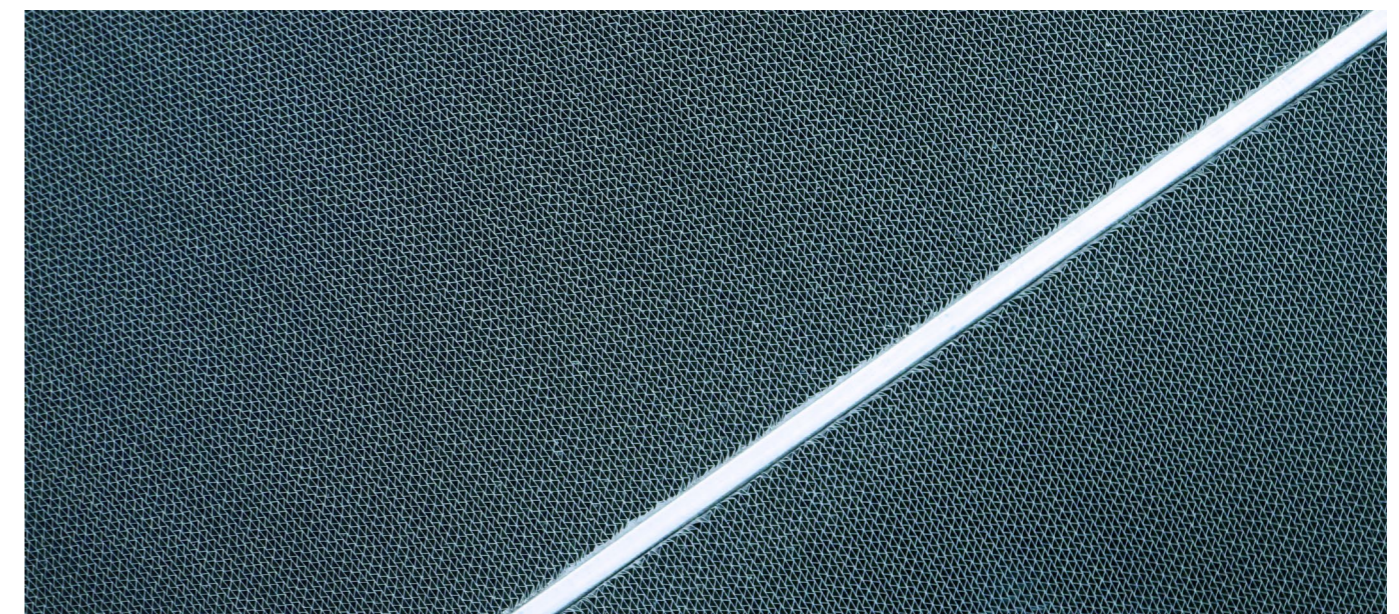

ROTARY HEAT EXCHANGER

# MODEL E & O

## Compact Casing

Model E is a high-performing and lightweight rotary heat exchanger designed for air handling units, primarily for comfort ventilation applications. Typical temperature efficiencies are up to 90%.

Model E offers one of the most compact galvanized steel casings available on the market. This gives an exceptional efficiency compared to conventional rotary exchangers with the same casing dimensions.

Model E's performance is certified according to Eurovent, AHRI, and TüvSüd. Model E also meets several hygiene requirements.

Only the wheel, without casing, is called Model O.

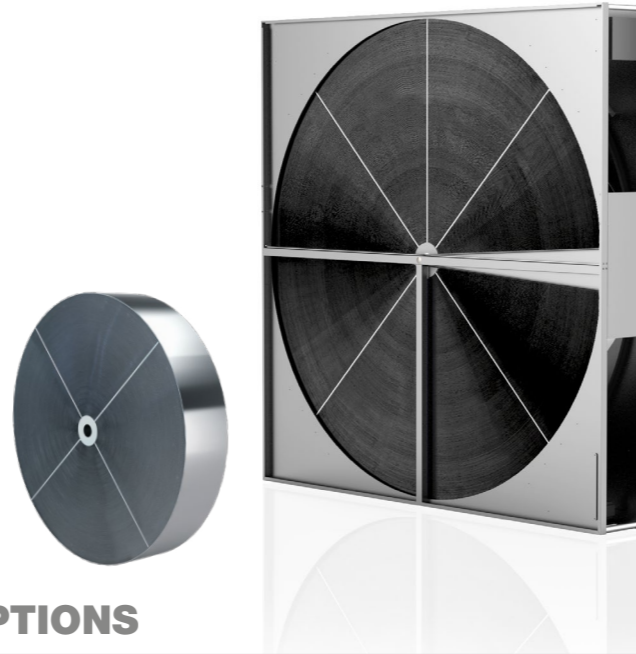

## TECHNICAL SPECIFICATIONS & OPTIONS

### MATRIX MATERIAL:

- Aluminum (Condensation)
- Epoxy (Condensation)
- Hybrid with molecular sieve (Enthalpy)
- Molecular sieve (Adsorption)

### EXCHANGER ORIENTATION:

- Vertical
- Horizontal

### HUB:

- Ball bearing with shaft
- Ball bearing with shaft, corrosion resistant

### CASING TYPE:

- Standard
- Covered

### AIRFLOW CAPACITY:

- 200 - 90 000 Nm<sup>3</sup>/h

### MAX. ALLOWED PRESSURE DROP:

- 300 Pa for <math>\varnothing</math>1600 mm
- 250 Pa for >math>\varnothing</math>1600 mm

### SEAL:

- Brush seal
- Special brush seal

### DRIVE EQUIPMENT:

- Advanced step drive and control with/ without Modbus
- Inverter ready constant speed drive
- Rotation detector

### DRIVE BELT:

- Round belt
- Power belt

### ADDITIONAL OPTIONS:

- Corrosion protected framework
- Inspection hatches
- Cable glands
- Condensate tray
- Hygienic certified casing

### RECOMMENDED VALUES FOR ALL ROTARY HEX:

- Maximum differential pressure up to 600 Pa
- Recommended pressure drop between 100 - 200 Pa
- Air temperature limits between min. -40°C and max 65°C

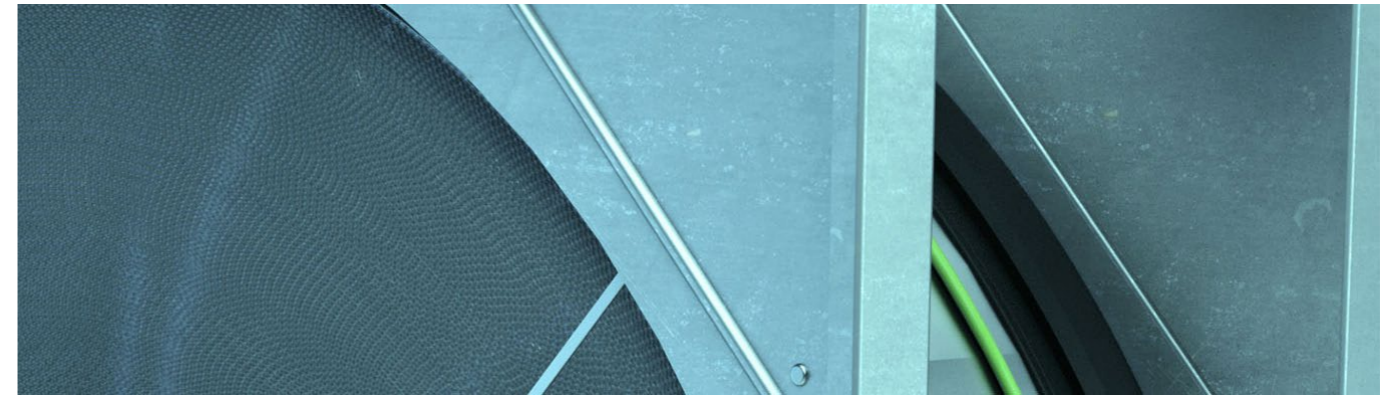

## MODEL E & O DIMENSIONS (MM)

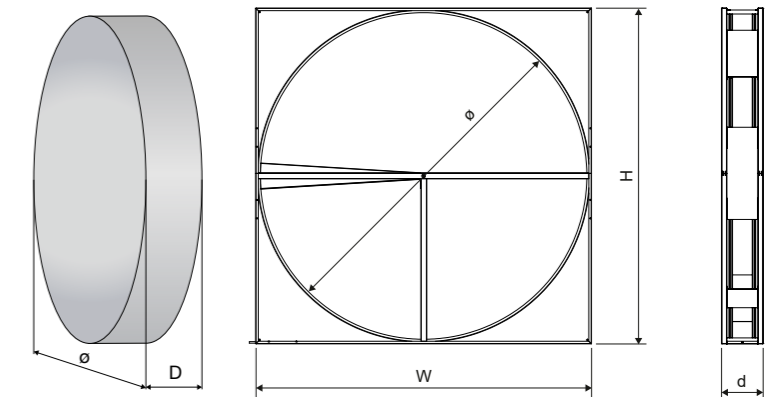

### NOTE:

Rotor diameter is available in 1 mm increments.  
Non-standard casing dimensions available.

WHEEL		CASING			
DIA (Ø)	DEPTH (D)	FRONT (WxH) (VARIABLE MOTOR)	FRONT (WxH) (CONSTANT DRIVE)	DEPTH (d)	WELL HEIGHT*
500	200	550 x 550	600 x 600	276	1.4** / 1.6 / 1.8 / 2.0 / 2.2 / 2.5
600	200	650 x 650	700 x 700	276	1.4** / 1.6 / 1.8 / 2.0 / 2.2 / 2.5
700	200	750 x 750	800 x 800	276	1.4** / 1.6 / 1.8 / 2.0 / 2.2 / 2.5
800	200	850 x 850	900 x 900	276	1.4** / 1.6 / 1.8 / 2.0 / 2.2 / 2.5
900	200	950 x 950	1000 x 1000	276	1.4** / 1.6 / 1.8 / 2.0 / 2.2 / 2.5
1000	200	1050 x 1050	1100 x 1100	276	1.4** / 1.6 / 1.8 / 2.0 / 2.2 / 2.5
1100	200	1150 x 1150	1200 x 1200	276	1.4** / 1.6 / 1.8 / 2.0 / 2.2 / 2.5
1200	200	1250 x 1250	1250 x 1250	316	1.4** / 1.6 / 1.8 / 2.0 / 2.2 / 2.5
1300	200	1350 x 1350	1350 x 1350	316	1.4** / 1.6 / 1.8 / 2.0 / 2.2 / 2.5
1400	200	1450 x 1450	1450 x 1450	316	1.4** / 1.6 / 1.8 / 2.0 / 2.2 / 2.5
1500	200	1550 x 1550	1550 x 1550	316	1.4** / 1.6 / 1.8 / 2.0 / 2.2 / 2.5
1600	200	1650 x 1650	1650 x 1650	316	1.4** / 1.6 / 1.8 / 2.0 / 2.2 / 2.5
1700	200	1750 x 1750	1750 x 1750	316	1.4** / 1.6 / 1.8 / 2.0 / 2.2 / 2.5
1800	200	1850 x 1850	1850 x 1850	316	1.4** / 1.6 / 1.8 / 2.0 / 2.2 / 2.5
1900	200	1950 x 1950	1950 x 1950	316	1.4** / 1.6 / 1.8 / 2.0 / 2.2 / 2.5
2000	200	2050 x 2050	2050 x 2050	316	1.4** / 1.6 / 1.8 / 2.0 / 2.2 / 2.5
2100	200	2150 x 2150	2150 x 2150	316	1.4** / 1.6 / 1.8 / 2.0 / 2.2 / 2.5
2200	200	2250 x 2250	2250 x 2250	316	1.4** / 1.6 / 1.8 / 2.0 / 2.2 / 2.5
2300	200	2350 x 2350	2350 x 2350	316	1.4** / 1.6 / 1.8 / 2.0 / 2.2 / 2.5
2400	200	2450 x 2450	2450 x 2450	316	1.4** / 1.6 / 1.8 / 2.0 / 2.2 / 2.5
2500	200	2550 x 2550	2550 x 2500	316	1.4** / 1.6 / 1.8 / 2.0 / 2.2 / 2.5
2575	200	2575 x 2575	2575 x 2575	316	1.4** / 1.6 / 1.8 / 2.0 / 2.2 / 2.5

\* The exact well height depends on the thickness of the material selected. See technical manual for exact dimensions.

\*\* Well height 1.4 is only available in Aluminum, Epoxy and Hybrid.

ROTARY HEAT EXCHANGER

# MODEL EQ & EV

## Segmented Rotor

Model EQ is a high-performing, segmented rotary heat exchanger in a robust galvanized steel casing for industrial and marine ventilation applications. Typical temperature efficiencies are up to 90%.

Thanks to its segmented wheel, Model EQ facilitates onsite installation or replacement in narrow spaces. It also provides for lower transportation costs. It is possible to make adjustments to the position of the shaft in all directions for a perfectly balanced fit in the air handling unit.

Model EQ is certified according to Eurovent and AHRI.

Only the wheel, without casing, is called Model EV.

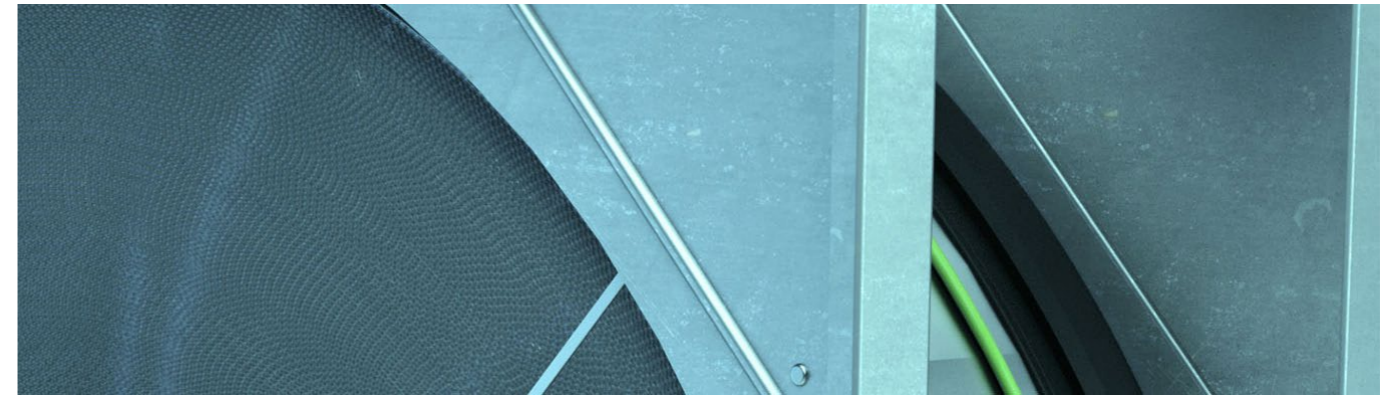
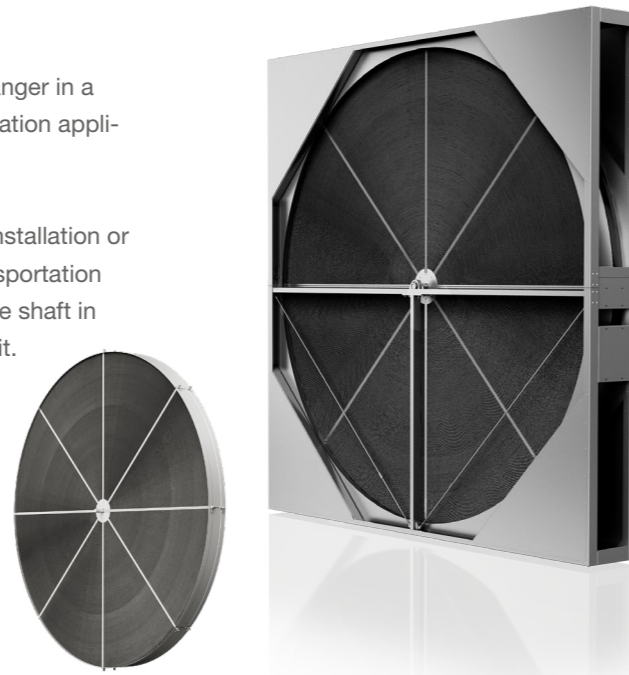

## TECHNICAL SPECIFICATIONS & OPTIONS

**MATRIX MATERIAL:**

- Aluminum (Condensation)
- Epoxy (Condensation)
- Hybrid with molecular sieve (Enthalpy)
- Molecular sieve (Adsorption)

**EXCHANGER ORIENTATION:**

- Vertical only

**HUB:**

- External bearing with fixed shaft
- Ball bearing with shaft, corrosion resistant

**CASING TYPE:**

- Standard
- Covered

**AIRFLOW CAPACITY:**

- 2 000 - 190 000 Nm<sup>3</sup>/h

**MAX. ALLOWED PRESSURE DROP:**

- 250 Pa

**DRIVE EQUIPMENT:**

- Drive and control (VFD)
- Inverter ready constant speed drive
- Rotation detector

**DRIVE BELT:**

- Power belt

**SEAL:**

- Brush seal
- Special brush seal

**ADDITIONAL OPTIONS:**

- Corrosion protected framework
- Inspection hatches
- Cable glands
- Condensate tray
- Hygienic certified casing
- Insulated casing

**RECOMMENDED VALUES FOR ALL ROTARY HEX:**

- Maximum differential pressure up to 600 Pa
- Recommended pressure drop between 100 - 200 Pa
- Air temperature limits between min. -40°C and max 65°C

## MODEL EQ & EV DIMENSIONS (MM)

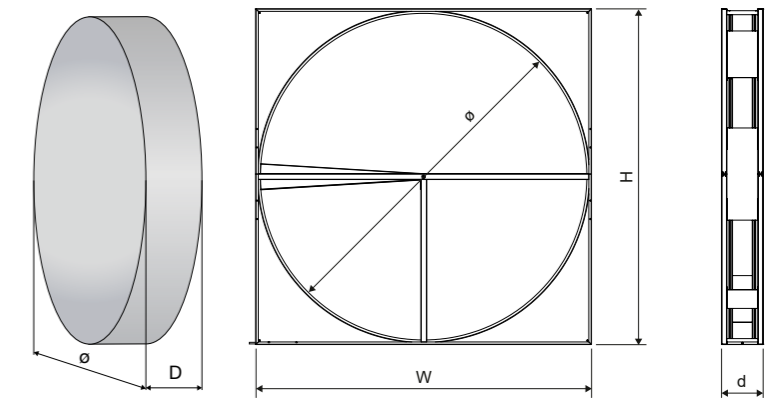

**NOTE:**

Rotor diameter is available in 1 mm increments.

Non-standard casing dimensions available.

WHEEL		CASING		
DIA (Ø)	DEPTH (D)	FRONT (W X H)	DEPTH (d)	WELL HEIGHT**
1600	200	1740x1740	456	1.4*** / 1.6 / 1.8 / 2.0 / 2.2 / 2.5
1700	200	1840x1840	456	1.4*** / 1.6 / 1.8 / 2.0 / 2.2 / 2.5
1800	200	1940x1940	456	1.4*** / 1.6 / 1.8 / 2.0 / 2.2 / 2.5
1900	200	2040x2040	456	1.4*** / 1.6 / 1.8 / 2.0 / 2.2 / 2.5
2000	200	2140x2140	460	1.4*** / 1.6 / 1.8 / 2.0 / 2.2 / 2.5
2100	200	2240x2240	460	1.4*** / 1.6 / 1.8 / 2.0 / 2.2 / 2.5
2200	200	2340x2340	460	1.4*** / 1.6 / 1.8 / 2.0 / 2.2 / 2.5
2300	200	2440x2440	460	1.4*** / 1.6 / 1.8 / 2.0 / 2.2 / 2.5
2400	200	2540x2540	460	1.4*** / 1.6 / 1.8 / 2.0 / 2.2 / 2.5
2500	200	2640x2640	460	1.4*** / 1.6 / 1.8 / 2.0 / 2.2 / 2.5
2600	200	2740x2740	460	1.4*** / 1.6 / 1.8 / 2.0 / 2.2 / 2.5
2700	200	2840x2840	460	1.4*** / 1.6 / 1.8 / 2.0 / 2.2 / 2.5
2800	200	2940x2940	460	1.4*** / 1.6 / 1.8 / 2.0 / 2.2 / 2.5
2900	200	3040x3040	500	1.4*** / 1.6 / 1.8 / 2.0 / 2.2 / 2.5
3000	200	3140x3140	500	1.4*** / 1.6 / 1.8 / 2.0 / 2.2 / 2.5
3100	200	3240x3240	500	1.4*** / 1.6 / 1.8 / 2.0 / 2.2 / 2.5
3200	200	3340x3340	500	1.4*** / 1.6 / 1.8 / 2.0 / 2.2 / 2.5
3300	200	3440x3440	500	1.4*** / 1.6 / 1.8 / 2.0 / 2.2 / 2.5
3400	200	3540x3540	500	1.4*** / 1.6 / 1.8 / 2.0 / 2.2 / 2.5
3500	200	3640x3640	500	1.4*** / 1.6 / 1.8 / 2.0 / 2.2 / 2.5
3600	200	3740x3740	500	1.4*** / 1.6 / 1.8 / 2.0 / 2.2 / 2.5
3700	200	3840x3840	500	1.4*** / 1.6 / 1.8 / 2.0 / 2.2 / 2.5
3800	200	3940x3940	500	1.4*** / 1.6 / 1.8 / 2.0 / 2.2 / 2.5
4000				

\*\* The exact well height depends on the thickness of the material selected. See technical manual for exact dimensions.

\*\*\* Well height 1.4 is only available in Aluminum, Epoxy and Hybrid.

ROTARY HEAT EXCHANGER

# MODEL EN

## Several Wheel Widths

Model EN is a high-performing small rotary heat exchanger without casing, designed to be fitted directly inside an air handling unit or mounted in a cassette, primarily for residential ventilation applications. Typical temperature efficiencies are between 75-80%, but with design optimization, the efficiency can approach 90%.

The product holds a smaller diameter hub and bearing, which maximizes the airflow for small residential air handlers. Further, glued aluminum wrapping allows for high output and durability. Model EN is available in different depths, adding one more dimension for perfection in residential air handling design.

Model EN is certified according to Eurovent.



## TECHNICAL SPECIFICATIONS & OPTIONS

**MATRIX MATERIAL:**

- Aluminum (Condensation)
- Epoxy (Condensation)
- Hybrid with molecular sieve (Enthalpy)
- Molecular sieve (Adsorption)

**EXCHANGER ORIENTATION:**

- Vertical
- Horizontal

**HUB:**

- Ball bearing with shaft

**AIRFLOW CAPACITY:**

- 50 - 2 000 Nm<sup>3</sup>/h

**RECOMMENDED VALUES FOR ALL ROTARY HEX:**

- Maximum differential pressure up to 600 Pa
- Recommended pressure drop between 100 - 200 Pa
- Air temperature limits between min. -40°C and max 65°C

**MAX. ALLOWED PRESSURE DROP:**

- 300 Pa

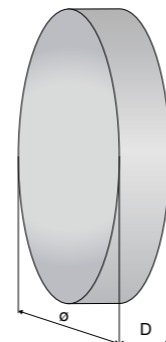

## DIMENSIONS (MM)

DIA (Ø)*	DEPTH (D)	WELL HEIGHT**
200 - 500	100*** / 150*** / 200	1.4**** / 1.6 / 1.8 / 2.0

\* Available in steps of 1 mm increments. For larger diameters please contact us!  
 \*\* The exact well height depends on the thickness of the material selected.  
 \*\*\* On request only.  
 \*\*\*\* Well height 1.4 is only available in Aluminum, Epoxy and Hybrid.

ROTARY HEAT EXCHANGER

# ADDITIONAL OPTIONS

**CORROSION PROTECTED FRAMEWORK**

Some applications require improved corrosion protection (e.g., marine environments).

A corrosion protected framework combined with an epoxy coated wheel and corrosion-resistant ball bearings increases the corrosion resistance significantly.



**INSPECTION HATCHES, CABLE GLANDS & CONDENSATE TRAY**

For easier access to the motor we provide optional hatches and cable glands.

For humid climates, we recommend adding a condensate tray to collect water and lead it out of the AHU.

The covered casing automatically comes with inspection hatches and cable glands to enable access to otherwise closed-off components.

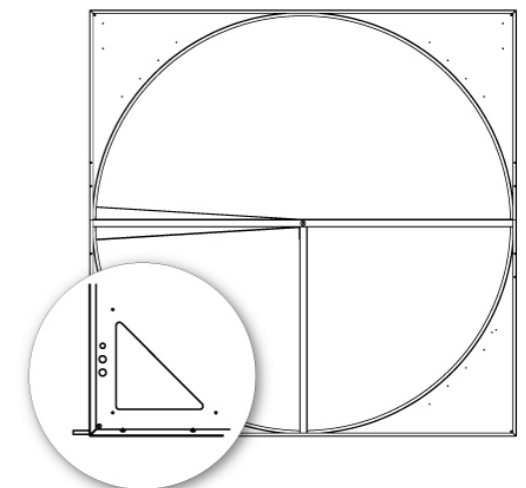

**PURGE SECTOR AND SPECIAL SEAL**

Models with casing can be equipped with special seals and a purge sector to minimize the cross-contamination of exhaust air into the supply air.

The purge sector is optimized to reduce carryover or EATR. It will stop the inlet of exhaust air in the small area right before the airflows switch, thus avoiding exhaust air from getting trapped into the matrix.

A small amount of the supply air is used to blow out the minor amount of exhaust air that might have been trapped to ensure a fresh and clean air supply.

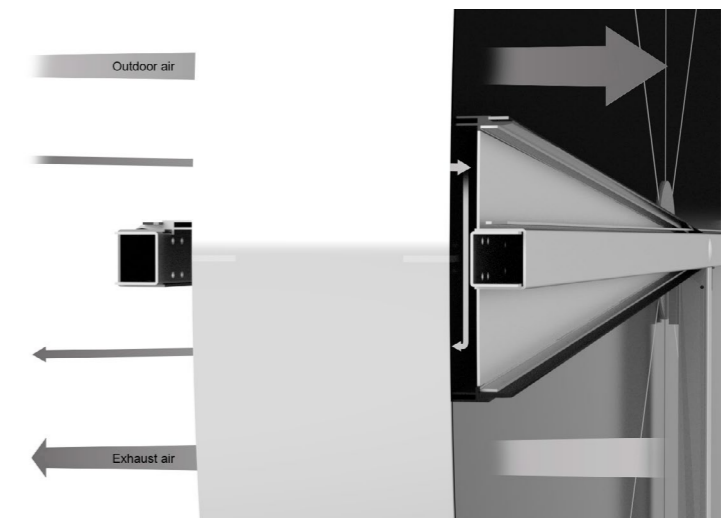



**HEAT EXCHANGER CALCULATION**

# PRODUCT SELECTION

Heatex Select, our calculation software, enables accurate calculations of our product performance under different conditions and the energy-saving potential in various geographical zones.

Heatex Select is always available online for free at [heatex.com](http://heatex.com).

All heat transfer and pressure drop calculations are done with the actual heat exchanger geometry and based on correlation from scientifically well-renowned sources such as "VDI Wärmeatlas" and "International Hand Book of Heat Exchanger Design".

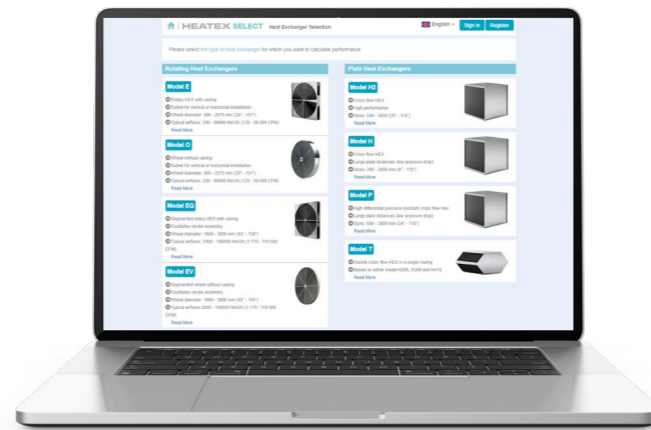

## HEATEX SELECT

**SAVING ENERGY & RESOURCES**

# RETURN ON INVESTMENT



A heat exchanger is almost always a beneficial investment – regardless of whether the exchanger is a rotary or a plate heat exchanger.

By recovering heat, energy consumption is reduced. Saved energy cut costs and the consumption of coal, natural gas, and other fossil fuels, which eventually leads to carbon dioxide reduction.

All our models save sufficient energy to provide short amortization periods and valuable savings.

In Heatex Select Online, you find a return on investment calculator that approximately indicates the payback amount and time as well as energy saved by installing a Heatex air-to-air heat exchanger.



**MANUFACTURING & LOGISTICS**

# PRODUCTION & ENVIRONMENT

Strategically located production facilities enable us to respond to regional product variations and demand as quickly as possible while assuring stable supply lines and highly trained staff.

Heatex' Lean Manufacturing certified personnel constantly manage towards perfection to reduce the number of steps, time, and information needed to serve our customers. By assuring efficient processes and reliable suppliers, we constantly aim to optimize production, reduce scrap and secure stable lead times, resulting in high-quality products with a competitive price and a minimal carbon footprint.



**HEALTH AND SAFETY**



Every Heatex production plant meets and goes beyond all relevant legislative requirements set out by the national government in each country to make sure its personnel is safe and sound.

In case of any accidents, the incident is registered, investigated, and analyzed. Preventive measures are put in place to eliminate any further issues.

**ENVIRONMENTAL FOCUS**

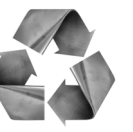

We are fully committed to developing our products, manufacturing processes, and procurement to reduce our carbon footprint and any harmful environmental impacts.

Together with EcoVadis, the world's most trusted provider of business sustainability ratings, we continuously work on improving our score. Both our products and our business practices are aimed at a sustainable future.



MEETING MINUTES

# YOUR NOTES

## HEATEX

### WHY HEATEX?

#### QUALITY PRODUCTS & TECHNICAL EXPERTISE

Our products are field-tested and designed to comply with all relevant building codes and regulations. We frequently send our products to independent labs worldwide for inspection and regularly evaluate product performance in our in-house testrig. Our skilled and experienced application engineers support you during the entire development process.

#### REPUTATION & CERTIFICATIONS

We have a well-established reputation for being honest and reliable and hold several certifications for product and operation quality worldwide, including Eurovent, AHRI, and ISO 9001. Our products are proven to have high efficiency and a fast ROI. All Heatex products are custom-made and designed to match each customer's technical specifications.

Visit [heatex.com](http://heatex.com) for more information.





# HEATEX

The Air-to-Air Heat Transfer Specialist